



PLASTIC OMNIUM

INFINITE INNOVATION

IAA-FRANKFURT 2017



CONTACTS

Adeline Mickeler +33 (0)1 40 87 64 00
amickeler@plasticomnium.com

Tarick Dali +33 (0)1 40 70 11 89
tdali@dgm-conseil.fr

67th IAA Cars
Frankfurt/Main, 14. - 20. September 2017

INNOVATION: A PROACTIVE STRATEGY

The revolution in automobiles is changing mobility habits and the energy sources used for propulsion. Also, regulations are becoming tougher and increasingly restrictive. For all these reasons, Plastic Omnium, the world leader in automotive exterior products, fuel tanks and pollution reduction systems, has made innovation central to its strategy for the past 70 years. The results are compelling: Plastic Omnium manages a 4,000-strong patent portfolio and in 2016 was ranked 25th in France for the number of patents filed*. Plastic Omnium manages a 4,000-strong patent portfolio and in 2016 was ranked 25th in France for the number of patents filed*.

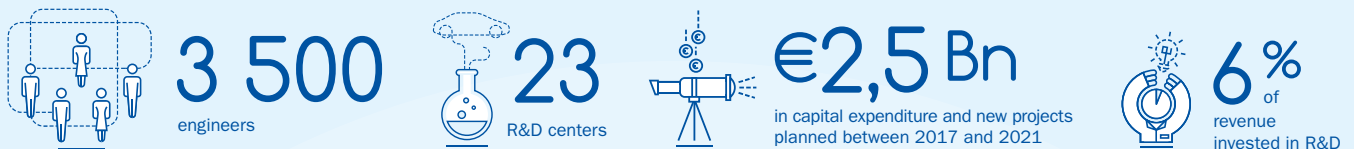

To boost its proactive R&D strategy, in 2016, Plastic Omnium added an Openlab ecosystem to enhance its Open Innovation capacity.

Advisory committee strengthened

Plastic Omnium set up an Automotive Strategic Advisory Committee to boost its innovation capacity.

Committee members are globally recognized independent experts, including the three latest recruits:

- Prof. Mathias Fink, an expert in wave propagation
- Prof. Emeritus Jay Lee, an expert in predictive data analysis
- Prof. Hiroaki Kitano, an expert in artificial intelligence.

Investment in diversified entrepreneurship

Plastic Omnium linked up with Israel's Elbit Systems to create EPO-Celltech, a startup specializing in fuel cells and supercapacitors.

Plastic Omnium also co-sponsors the Aster Capital venture capital fund, which invests in startups that develop solutions in new energy sources, connected mobility and innovative materials.

Close-knit university partnerships

Plastic Omnium has numerous partnerships, notably with:

- Technion, the Israel Institute of Technology
- The Massachusetts Institute of Technology (MIT)
- The Technical University of Denmark (DTU)

Plastic Omnium is also a member of the Hydrogen Council launched by leading multinationals.

Innovation challenges

In its Open Innovation research, Plastic Omnium explores new ways of stimulating innovation, both in-house and outside the company:

- The PO Innovation Award: stimulating and recognizing innovations proposed by employees, whatever their job in the company.
- Hackathon
- Crowdsourcing



*Source : INPI April 2017



Tomorrow's clean, connected car

Environmental standards are undergoing constant change. At Plastic Omnium, we take these standards into account to invent tomorrow's vehicle, embedding innovations in a sustainable development approach. Our goal is to offer automakers cutting-edge equipment and solutions that will bring to life tomorrow's clean, connected car.

Stricter environmental requirements

Lighter vehicles

Making vehicles lighter reduces their CO₂ emissions. Plastic Omnium "lightweights" its exterior products by using plastic components and modules that are 30% lighter than metal while offering excellent mechanical performance and robustness. Plastic Omnium's technologies lighten vehicles by up to 200 kg, which translates into 20 g less CO₂ per kilometer.

Reducing component weight is also vital for hybrid and electric vehicles as it increases their driving range and compensates for the battery weight.

Plastic Omnium's expert engineers also offer automakers solutions to optimize passive and active aerodynamics, further reducing CO₂ emissions by over 4 g/km.

The energy mix revolution

Plastic Omnium is the leader in energy storage systems, whether for standard gasoline and diesel vehicles as well as hybrids. Standard engines remain in the majority in 2017, but by 2030 almost 45% of new vehicles will have hybrid powertrains, compared

with 6% in 2017. Continuous improvement programs are active for current storage systems, and Plastic Omnium is also working on alternative energy solutions such as hydrogen storage, fuel cells and supercapacitors.

More connected than ever

The market for connected cars is on the increase. According to a study by PwC*, between 2015 and 2020 the market is set to quadruple to €115 billion in revenue, to the benefit of two priority segments: safety (€47 billion) and assisted driving (€35 billion).

Plastic Omnium's development strategy is staying ahead of market changes. Plastic Omnium bumpers currently include up to 50 high-tech components that augment driver intelligence and make driving easier and safer.

Plastic Omnium is contributing to tomorrow's intelligent car thanks to its expertise in function integration, backed by the outstanding electromagnetic transparency performance of plastics. The company's exterior components will incorporate a large number of radars and other sensors that will offer even greater styling flexibility on top of protective features.

*Source: Strategy& PwC study "Connected Car report 2016"

PLASTIC OMNIUM'S VISION OF THE 2030 CONCEPT CAR:

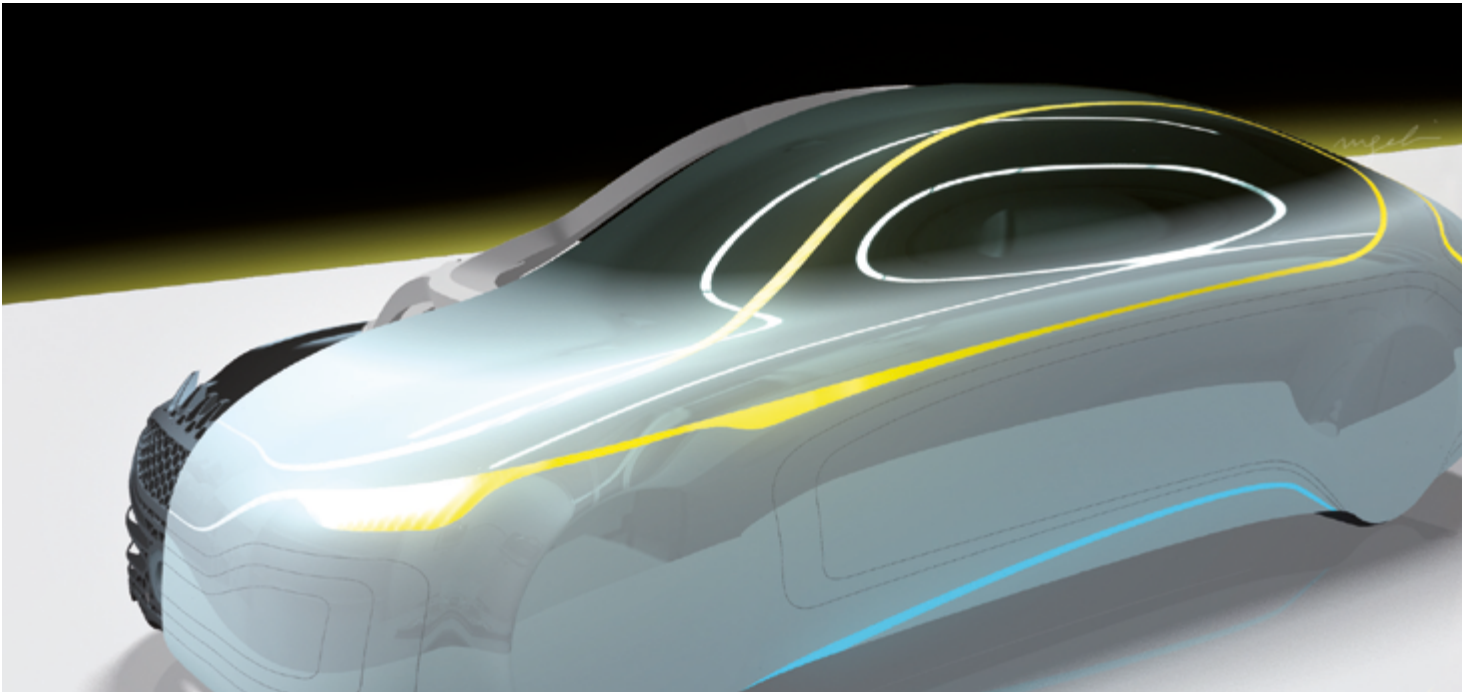

The Living Body concept car: intelligence at work

Plastic Omnium is already hard at work on inventing the car of the future. The company's expertise is being brought to bear to make cars lighter and more intelligent while bolstering Plastic Omnium's commitments to safety and sustainable mobility. Living Body was designed using the biomimetic concept that mimics nature. The result is a vehicle that is safer, cleaner, more intelligent and performs better.

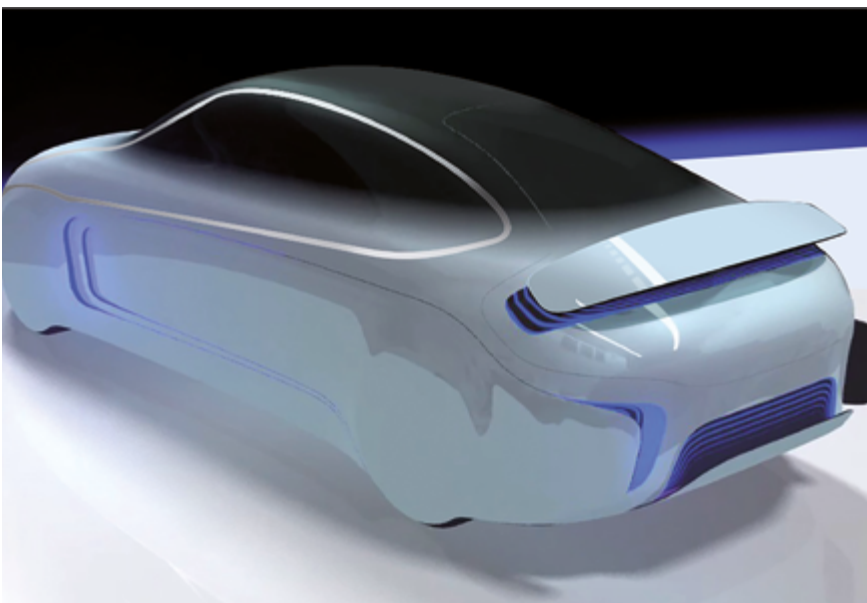

Living Body communicates with its surroundings

Thanks to the lighting system integrated into the Living Body structure, the vehicle can communicate and interact with its surroundings.

Distinctive design for each model, personalization, and above all optimal safety

due to driving signals that respond independently to the surroundings: light indicators respond to pedestrians and the tailgate sends out messages to vehicles behind.

Environmental protection

Improved aerodynamics: Expertise in aerodynamics is applied to save energy. Moveable front fenders and a rear spoiler adapt to vehicle speed, reducing drag. This innovation also improves battery cooling and the drag coefficient, in turn reducing the energy needed to propel the vehicle and increasing its range.

No polluting emissions: The car works through a transformation of hydrogen in a fuel cell. The air entering the vehicle interacts in the fuel cell with hydrogen to create electricity for the vehicle's electric motor without forming any polluting emissions—Living Body discharges nothing other than water, making the vehicle 100% clean.

Lower energy consumption: Optimal integration of the fuel cell and hydrogen tanks is made possible by lightening the components, along with the frame and floor structure. As the vehicle is lighter, it consumes less energy and its range is increased.

High power capacitor, or supercapacitors, can recover vehicle brake energy so that no energy is lost as occurs in mechanical braking. This again increases driving range. The energy efficiency of a fuel cell and electric motor combination is far higher than that of an internal combustion engine. The result is reduced energy consumption and increased range. In winter, the heat generated by the fuel cell is reused to heat the car cabin. This maintains driving range even when temperatures are very low.

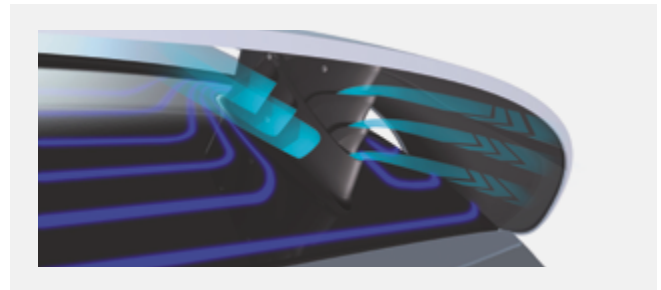

Greater freedom and driving pleasure

One important goal of Plastic Omnium innovation is to increase driving pleasure while continuously improving vehicle efficiency. Living Body will be easier and more enjoyable to drive.

A dynamic ride

without affecting driving range: the supercapacitor recovers brake energy and uses it during acceleration.

The energy stored in the supercapacitor increases engine peak power

Total freedom and no compromises:

hydrogen power will provide a driving range of 800 km for just three minutes of charge time.

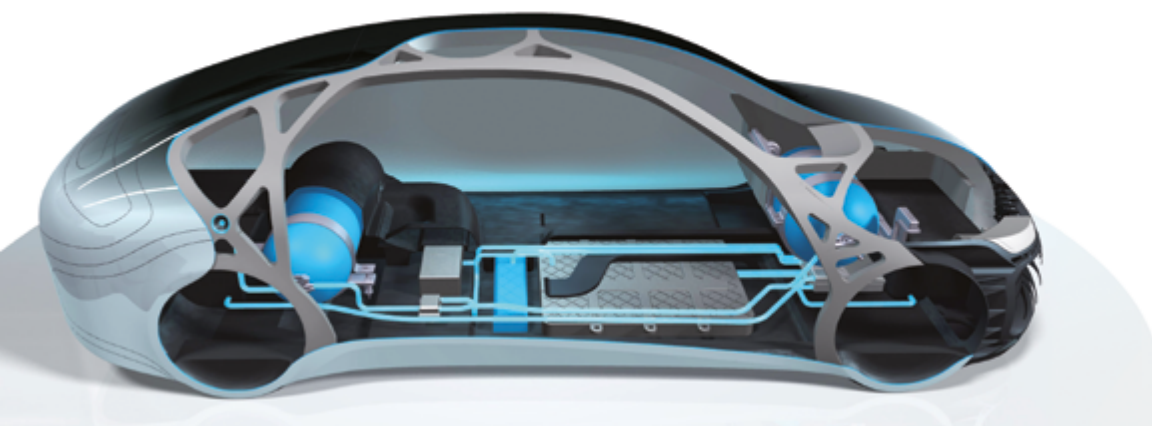

PLASTIC OMNIUM INNOVATIONS IN 2017:

More-intelligent bumpers

Integrated radar

Plastic Omnium has developed intelligent bumpers that include optimally mounted radars in place of standard parking sensors. Radars developed with our partners are fully integrated into the bumpers and provide first-class performance thanks to electromagnetic-wave permeable plastics.

Integrated radar for enhanced styling.

Impact detection and absorption system

The engineering procedure for bumpers patented by Plastic Omnium offers an impact absorption module that incorporates a host of functions ranging from innovative detection systems to improved impact management. The bumper also includes an active aerodynamic system. The new bumper module replaces seven separate components; it is also lighter, reducing CO₂ emissions.

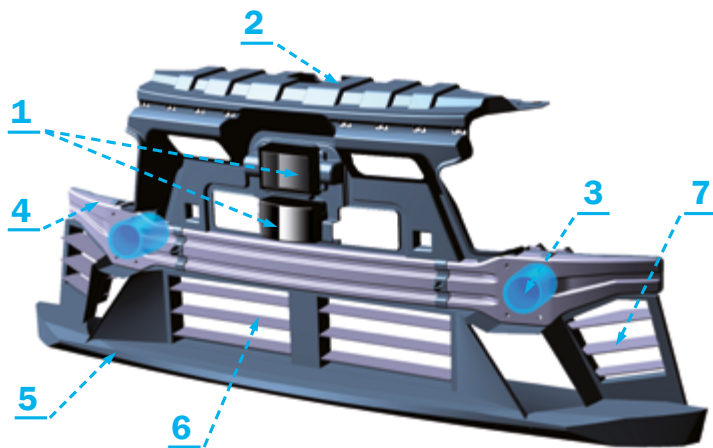

- 1. Lidar and radar adaptive cruise control (ACC)
- 2. Bumper reinforcement
- 3. Crash box in high-performance composites
- 4. Shock absorption beam
- 5. Pedestrian safety system
- 6. Active air-flow management for engine cooling
- 7. Active flow management for air exchangers

5 kg lighter,
reducing CO₂
by 0.5 g per km.

More
aerodynamic,
reducing CO₂
by an extra 2 g per km.

Innovative front grille

Plastic Omnium has developed a manufacturing process that incorporates modern radar technologies in an innovative, three-function front grille:

A chrome finish compatible with radars
(previously impossible).

De-icing system
to ensure the grille works
in all weathers.

An integrated
lighting system
based on flexible optical fibers.



A lighter, more reactive tailgate

The new-generation tailgate is made from high-performance composites that reduce weight by around **30%** compared with steel. Thanks to the light plastic materials, many new aerodynamic and interactive functions can be integrated.

Safety and personalization

The tailgate can display messages to “talk” to its surroundings. Many different messages can be displayed on a transparent area that also serves to display the driver’s own personalized messages.



An interactive tailgate

Solutions have been developed that enable the tailgate to interact in three ways:

- The facial recognition system uses a specific software program to open the vehicle
- The “touch and open” and “touch and stop” systems work through conductive paint
- The obstacle avoidance system for ground level or higher levels avoids damage when opening the trunk.

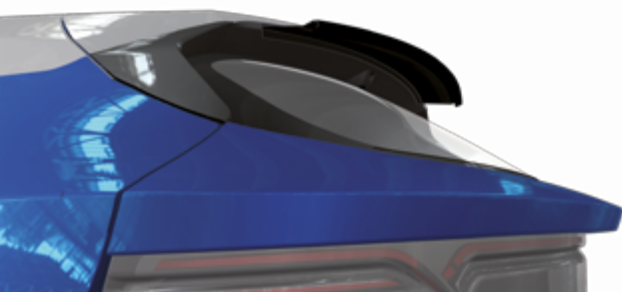

CO₂ emissions reduced
by as much as 2 g per km.

A more aerodynamic tailgate

Tailgate aerodynamics are improved by an active rear spoiler and a side spoiler that direct the air better over the car roof. The drag coefficient is improved by 3-4%, reducing CO₂ emissions by 1 g per km.

In addition, a mobile diffuser in the rear bumper spreads out under the floor to improve the drag coefficient by a further 3% and reduce CO₂ emissions by 1 g per km.



Cleaner energy

Plastic Omnium is the global leader in low emission fuel and exhaust treatment systems, equipping one in every five vehicles produced worldwide. As environmental standards become increasingly strict, Plastic Omnium helps automakers reduce emissions.

Solutions for hybrid motors

Plastic Omnium offers solutions for plug-in hybrids.

The INWIN fuel system's optimal architecture withstands increased gasoline vapor pressure when the vehicle is running on electricity.

TANKTRONIC®'s innovative, simplified architecture includes an E-valve with an electronic control device. The system improves operation at low cost.

64 PATENTS

filed by Plastic Omnium for the INWIN and TANKTRONIC® solutions.



Clean diesel: the SCR*

SCR technology has been applied to diesel fueled vehicles since 2008 to treat nitrogen oxide (NOx) emissions in compliance with the strictest regulations.

The technology involves vaporizing AdBlue® into the exhaust which, when it comes into contact with diesel exhaust gases, generates a chemical reaction that transforms polluting nitrogen oxides into harmless nitrogen and water vapor.

*Selective Catalytic Reduction

SCR solutions reduce NOx emissions by almost 95%.

SCR solutions reduce CO₂ emissions by up to 5%.

OVER 172 PATENTS

filed by Plastic Omnium for its SCR solutions.

OVER 1 MILLION SCR

systems sold by Plastic Omnium in 2017.



PLASTIC OMNIUM INNOVATIONS IN 2017:

Water injection system

Plastic Omnium has developed a technology that can be adapted for all gasoline vehicles. First designed to improve engine performance, the water injection system significantly reduces fuel consumption, which in turn reduces CO₂ emissions.

CO₂ emissions reduced by up to 15%.

A cost-effective solution.



Hybrid solution: The supercapacitor

Supercapacitors can recover brake energy and use it for vehicle start-up. The Plastic Omnium supercapacitor is highly cost-effective and environment friendly.

up to 15%
CO₂ emissions
reduction.

Start and stop,
regenerative braking,
and peak power assist.

Costs less
than Li-ion batteries
for equivalent power.

100%
recyclable.

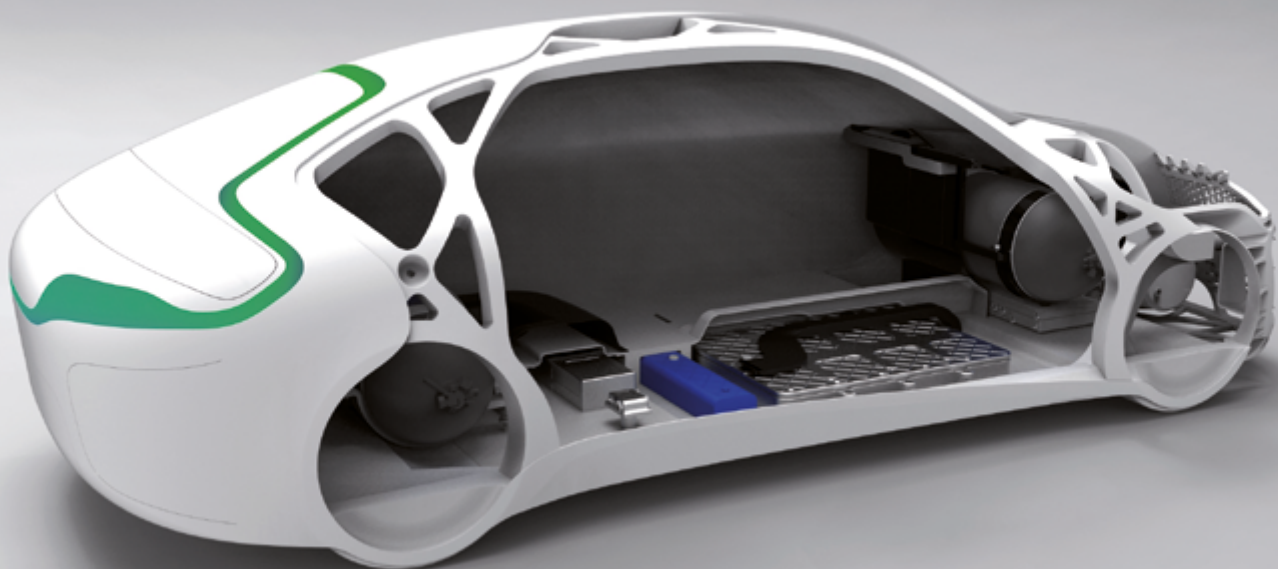

Hydrogen: Tomorrow's clean fuel?

Plastic Omnium has developed a high-pressure hydrogen storage system.

The hydrogen is stored in type IV* tanks that can withstand internal stresses.

The tank is made from a thermoplastic sealing liner of around 5-mm and a thick carbon-fiber layer that takes up the mechanical stresses created by internal pressure in the tank.

Plastic Omnium's R&D has been working on a technology for several years that now enables it to present a 700-bar tank.

When fitted with two 60-liter tanks, a vehicle's driving range can be as high as 800 km.

*Tanks made of composite materials and plastics

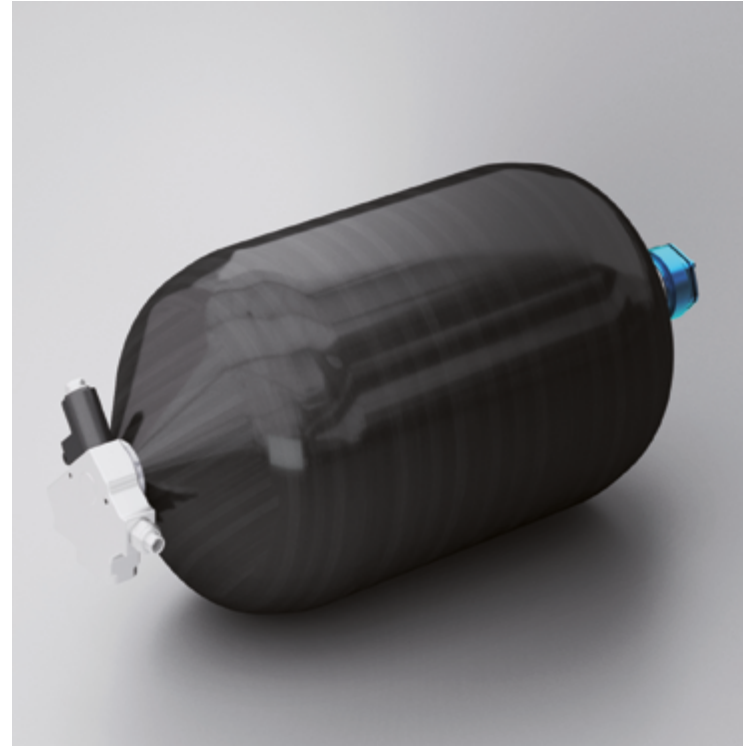

**3 to 4
minutes:**

the time needed to
fill a vehicle at a
hydrogen station.

800 km:

the distance traveled on a
2x 60-liter tank system.

4 times lighter

than metal systems thanks to its
carbon fiber and plastic components.

Fuel cell system: A zero-emission solution

From hydrogen to electrical energy

One focus of innovation at Plastic Omnium is to power electric vehicle motors with a fuel cell.

The cell converts oxygen and tank-stored hydrogen into electrical energy to propel the vehicle.

The system discharges nothing other than water and heat.

The solution of a new-generation fuel cell combined with tank-stored hydrogen is much lighter than standard battery solutions and provides a driving range equivalent to today's gasoline or diesel cars.



Fuel cells combined with tank-stored hydrogen will free electric vehicles from the problems of limited range and lengthy charging times, as well as their dependence on weather conditions. Such issues are currently holding back electric vehicle development.

In 2016, Plastic Omnium and Elbit Systems, an Israeli company, created EPO-Celltech, a startup specializing in fuel cells and supercapacitors. A joint research center opened in mid-2016 in Caesarea in Israel. Plastic Omnium is contributing its automotive expertise in electronic system and fluid management. Plastic Omnium's know-how is combined with the developments already achieved by Elbit Systems in creating a fuel cell with very low precious-metal content along with a new supercapacitor range.

The research team comprises 50 people based in Belgium and Israel.

No pollutant emissions:
the vehicle emits only water.

Enhanced energy efficiency
compared with internal combustion engines.

Range unaffected by weather conditions
as fuel-cell heat is recovered to heat car cabin.

1. Air enters the vehicle.
2. The air reaches the fuel cell.
3. The hydrogen reacts with the oxygen in the fuel cell.
4. The electricity generated by the fuel cell supplies the motor.
5. The motor propels the vehicle.
6. The vehicle emits nothing other than water.

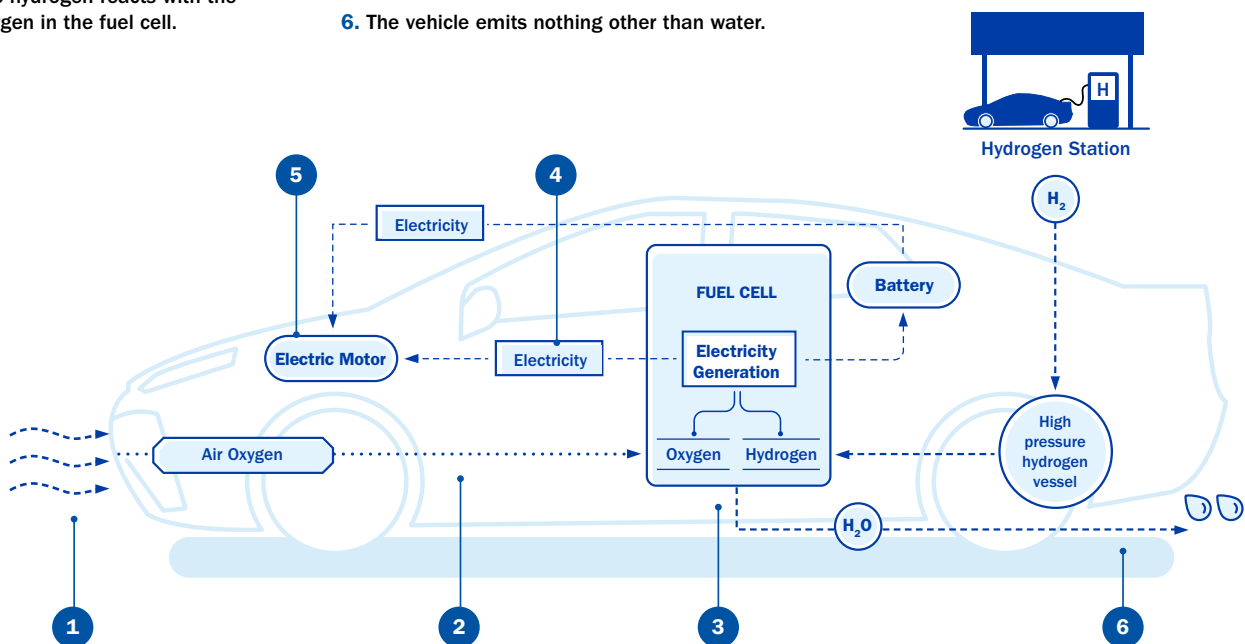

ABOUT PLASTIC OMNIUM

Through innovation and anticipating market trends, the company has been able to grasp all opportunities on offer throughout its 70-year history.

Plastic Omnium is the world leader in exterior products and modules and fuel systems for automobiles.

WORLD LEADER IN 2 FIELDS:

Exterior products

designs, develops and manufactures exterior products and modules in plastic or composite materials; **one vehicle in seven produced around the world has parts supplied by Plastic Omnium.** 27 million bumpers produce annually.

Propulsion

designs, develops and manufactures fuel systems and pollution reduction systems; **one vehicle in five produced around the world has systems supplied by Plastic Omnium.** 20 million tank systems produce annually.

74 automaker customers



124
production
plants around
the world

32 000
employees

29th
global equipment
supplier

Revenue of
€8 Bn

1, allée Pierre Burelle 92593 Levallois Cedex - France
Tél. : +33 (0)1 40 87 64 00 - Fax : +33 (0)1 47 39 78 98
www.plasticomnium.com



PLASTIC OMNIUM

INFINITE INNOVATION